

SAFETY, OPERATIONS & PARTS MANUAL



www.machineryhouse.com.au

Chain Blocks

1 tonne, 1.5 tonne, 2 tonne
model capacities

COMPLIES TO AS/NZS 1418.2



General Information



CHAIN BLOCK

This manual contains important information to help you properly install, operate and maintain your Chain Block for maximum performance, economy and safety. Please study its contents thoroughly before putting your Chain Block into operation. By practicing correct operating procedures and by carrying out the recommended preventative maintenance suggestions, you will be assured of long, dependable and safe service.

After you have completely familiarised yourself with the contents of this manual, we recommend that you carefully file it for future reference.

The information herein is directed to the proper use, care and maintenance of the Chain Block and does not comprise a handbook on the broad subject of rigging. Rigging can be defined as the process of lifting and moving heavy loads using hoists and other mechanical equipment. Skill acquired through specialised experience and study is essential to safe rigging operations. For rigging information, we recommend consulting a standard textbook on the subject.

Unpacking

After opening the carton, the Chain Block should be carefully inspected for damage which may have occurred during shipment or handling. Check the Chain Block frame for dents or cracks and inspect the load chain for nicks and gouges. If shipping damage has occurred, contact your local supplier.

WARNING

Operating a unit with obvious external damage may cause load to drop and that may result in personal injury and/or property damage.

TO AVOID INJURY

Carefully check unit for external damage prior to installation.

Operating Instructions

After mounting and before placing in service, check the Chain Block for proper operation. To operate the Chain Block, pull on the hand chain as indicated.

Operate the Chain Block with no load and then a light load of approximately 20kg. To make sure it operates properly and the brake holds the load when the hand chain is released, then operate with a rated load as shown on the capacity plate.

WARNING

TO AVOID INJURY

Stop operating in the lifting direction when the hook block contacts the hoist frame and /or hanger, as noted by sudden increase in hand chain pull or tipping of the hook block.

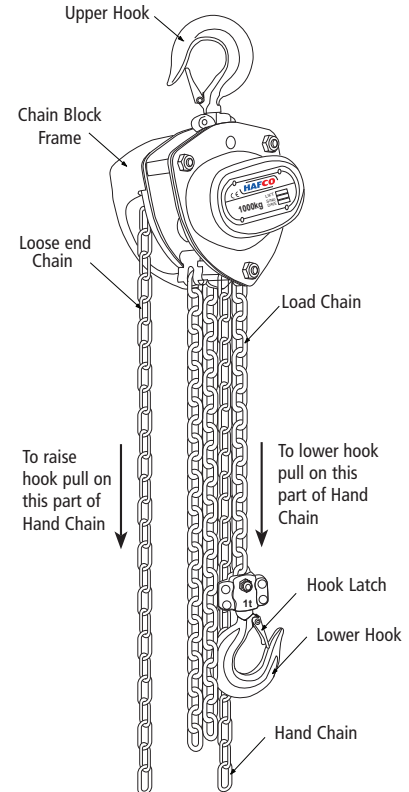

Choose the right Chain Block for the job

Choose a Chain Block with the capacity for the job. Know the capacities of your loads, then match them. The application, the size and type of load, the attachments to be used and the period of use must also be taken into consideration in selecting the right chain block for the job. Remember the chain block was designed to ease our burden, and carelessness not only endangers the operator, but in many cases, a valuable load.

Inspect

All Chain Blocks should be visually inspected before use, in addition to regular periodic maintenance inspections. Inspect Chain block for operations warning notices and legibility. Deficiencies should be noted and brought to the attention of supervisors. Be sure defective Chain Blocks are tagged and taken out of service until repairs are made. Under no circumstances should you operate a malfunctioning Chain Block. Check for gouged, twisted, distorted links and foreign material. Do not operate Chain Blocks with twisted, kinked or damaged chain links. Load chain should be properly lubricated. Hooks that are bent, worn or whose openings are enlarged beyond normal throat opening should not be used. If latch does not engage in throat opening of hook, Chain Block should be taken out of service. Chains should be checked for deposits of foreign material, which may be carried into the Chain Block mechanism. Check brake for evidence of slippage under load.

Each Baoli Chain Block is built in accordance with the specifications contained herein and at time of manufacture complies with our interpretation of applicable sections of the Australian Standard AS1418.2.

*Copies of this standard can be obtained from Standards Australia.



The symbol points out important safety instructions which if not followed could endanger the personnel safety and / or property of yourself and others. Read and follow all instructions in this manual and any provided with the equipment before attempting to operate you Baoli Chain Block.

Consult Baoli for any usage of Baoli Chain Blocks that does not involve raising of the load on the lower hook, or usage of Baoli Chain Blocks in the inverted position. Using Chain Blocks without special precautions, in such applications may cause an accident that could result in injury and/or property damage.

Do's and Do Not's

Safe Operation of Chain Blocks

The following are Do's and Do Not's for safe operation of overhead Chain Blocks. Taking precedence over any specific rule listed here, however, is the most important rule of all, Use Common Sense. A few minutes spent reading these rules can make an operator aware of dangerous practices to avoid and precautions to take for his own safety and the safety of others. Frequent examination and periodic inspections of the equipment as well as a conscientious observance of safety rules may save lives as well as time and money.

WARNING

TO AVOID INJURY

1. **DO** be familiar with chain block operating controls, procedures and warnings.
2. **DO** make sure the chain block suspension hook is securely attached to a suitable support.
3. **DO** maintain a firm footing or be otherwise secured when operating chain block.
4. **DO** make sure that load slings or other approved sling attachments are properly sized and seated in the hook saddle.
5. **DO** make sure that the hook latch, is closed and not supporting any part of the load.
6. **DO** make sure that the load is free to move and will clear all obstructions.
7. **DO** take up slack chain carefully, check load balance, lift a few centimetres and check load holding action before continuing.
8. **DO** make sure that all persons stay clear of the suspended load.
9. **DO** avoid swinging of load or load hook.
10. **DO** protect load chain from weld spatter or other damaging contaminants.
11. **DO** promptly report any malfunction, unusual performance, or damage of the chain block.
12. **DO** inspect chain block regularly, replace damaged or worn parts and keep appropriate records of maintenance.
13. **DO** use Baoli genuine parts when repairing a chain block.
14. **DO** use hook latches wherever possible.
15. **DO** apply lubricant to the load chain as recommended in this manual.
16. **DO** replace damaged or malfunctioning hook latch.
17. **DO NOT** lift more than rated load.
18. **DO NOT** use damaged chain block or chain block that is not working correctly.
19. **DO NOT** use the chain block with twisted, kinked, damaged or worn chain.
20. **DO NOT** lift a load unless chain is properly seated in chain wheel(s).
21. **DO NOT** use load chain as a sling or wrap chain around load.
22. **DO NOT** lift a load if any binding prevents equal loading on all supporting chains.
23. **DO NOT** apply the load to the tip of the hook.
24. **DO NOT** operate unless load is centred under chain block.
25. **DO NOT** operate chain block with other than manual power.
26. **DO NOT** permit more than one operator to pull on a single hand chain at one time.
27. **DO NOT** allow your attention to be diverted from operating the chain block.
28. **DO NOT** operate the chain block beyond limits of load chain travel.
29. **DO NOT** use chain block to lift, support or transport people.
30. **DO NOT** lift loads over people.
31. **DO NOT** leave a suspended load unattended unless specific precautions have been taken.
32. **DO NOT** allow sharp contact between two chain blocks or between chain block and obstructions.
33. **DO NOT** allow the chain or hook to be used as a earth for welding.
34. **DO NOT** allow the chain or hook to be touched by a live welding electrode.
35. **DO NOT** remove or obscure the warnings on the chain block.
36. **DO NOT** adjust or repair a chain block unless qualified to perform chain block maintenance.
37. **DO NOT** attempt to lengthen the load chain or repair damaged load chain.

Safety Procedures

1. The chain block must always be rigged to lift in a straight line from hook to hook. The chain block must always be free to swivel on the upper hook. Under no conditions should the chain block frame be allowed to bear on any support when in use as this would cause bending of the hook or frame and damage the unit.
2. When preparing to lift or move a load, be sure that the attachments to both hooks are firmly seated in the saddles of the hooks. Avoid off centre loading of any kind especially loading on the tip of the hook. Also observe that the chain hangs straight (without twists) from chain block to lower hook.
3. When lifting, raise the load only enough to clear the floor or support and check to be sure brake will hold the load and that attachments to the load are firmly seated. Continue the lift only after you are assured the load is free of all obstructions.
4. Do not load beyond the rated capacity of the chain block. Rated capacity can be achieved with the following hand chain pulls. Since these hand chain pulls can easily be applied by one person, under no circumstances should more than one person operate the hoist hand chain. Overloading can cause immediate failure of some load carrying parts or result in damage causing failure at less than rated capacity. When in doubt use the next larger capacity Baoli Chain Block.

Chain Block Rated Load Kg	Hand Chain Pull to Lift Rated Load N
1000	284
1500	380
2000	343

WARNING

Exceeding the rated capacity of the chain block may cause load to fall.

TO AVOID INJURY

Do not exceed the hand chain pulls specified in safety procedure 4.

5. Do not wrap load chain around the load or bring the load in contact with the chain block. Doing this will result in the loss of the swivel effect of the hook which could mean twisted chain and jammed liftwheel. The chain could be damaged at the hook.
6. Stand clear of all loads and avoid moving load over the heads of other personnel. Warn personnel of your intention to move a load in their area.
7. Do not leave the load in the air unattended.
8. Do not lower the hook to a point where the chain becomes taut between the liftwheel and loose end pin.
9. Do not run the lower hook block into the chain block frame. Frame and /or chain guide damage may result.
10. The chain block has been designed for manual operation only.

WARNING

SPECIAL NOTE FOR USER:

TWISTING OF CHAIN

3, 5, 10, 20 and 30 tonne Chain Blocks have multiple falls of load chain. **THE LOAD CHAIN MUST BE INSPECTED FOR TWIST PRIOR TO EACH LIFT.** If the Chain Block bottom hook has looped through the multi fall of load chain this can create a twist in the load chain that can damage the Chain Block and cause injury.

Dispersion Safety Warnings

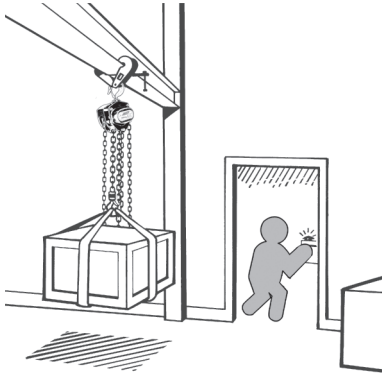

DO NOT leave a load suspended on the chain block unattended.

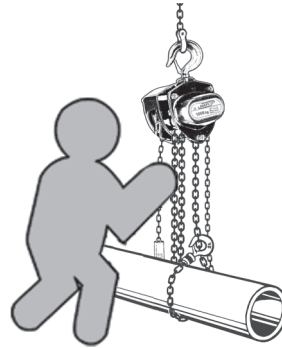

DO NOT wrap the load chain around the load and hook onto itself as a choker chain or bring the load in contact with the chain block.

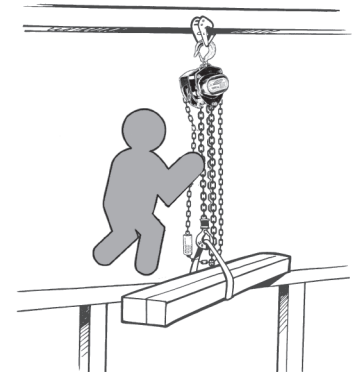

DO NOT hold the load chain in a loaded state while operating the chain block as serious injury may occur if the brake did not operate properly.

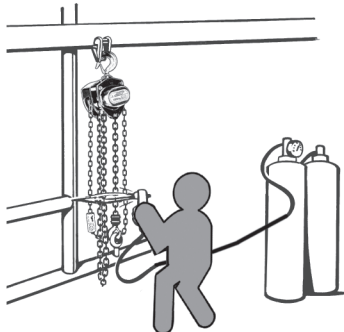

DO NOT heat treat and **DO NOT** weld any part of the chain block, especially the load chain.

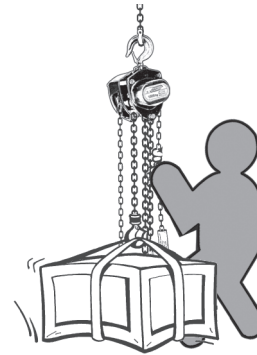

DO NOT attempt to lift load beyond the rated capacity.

Safety Warnings



CHAIN BLOCK

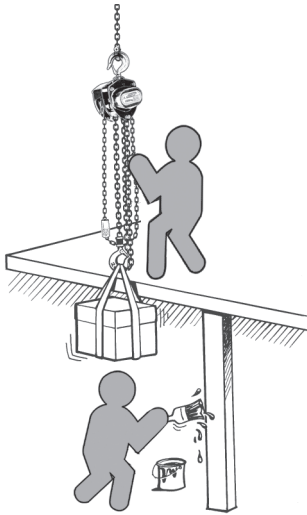

DO NOT use the chain block for lifting or moving people, or lifting loads over people.

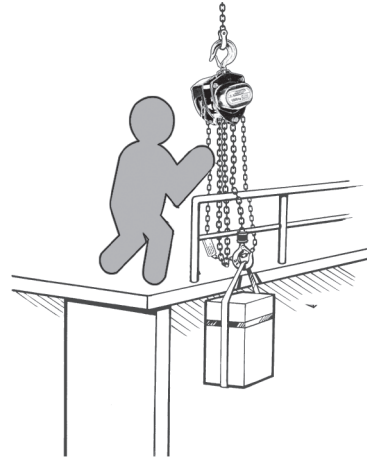

DO NOT operate the chain block unless it is rigged to pull in a straight line from hook to hook, and the frame is allowed to freely swivel on the upper hook.



DO NOT run the hook assembly into the frame of the block.



DO NOT shock load chain block, chain or hook.

Inspection

To maintain continuous and satisfactory operation, a regular inspection procedure must be initiated so that worn or damaged parts can be replaced before they become unsafe. The intervals of inspection must be determined by the individual application and are based upon the type of service to which the chain block will be subjected. The inspection of chain blocks is divided into two general classifications designated as frequent and periodic.

Frequent Inspections

These inspections are usually visual examinations by the operator or other designated personnel. The frequent inspections are to be performed daily or monthly and shall include the following items:

- a. Braking mechanism for evidence of slippage - Daily.
- b. Load chain for lubricant, wear, damaged links or foreign material - Daily.
- c. Hooks for damage, cracks, twists, latch engagement and latch operation - Monthly.

Any deficiencies noted are to be corrected before the chain block is returned to service.

Periodic Inspections

These are visual inspections by an appointed person who makes records of apparent external conditions to provide the basis for a continuing evaluation. For normal service, the periodic inspections are to be performed yearly and for heavy service, the periodic inspections are to be performed semi-annually. Due to the construction of the chain block, it will be necessary to partially disassemble the unit to perform the periodic inspections. The periodic inspections are to include those items listed under frequent inspections as well as the following:

- a. Chain for excessive wear or stretch.

- b. Worn, cracked or distorted parts such as hook blocks, chain guide, stripper, loose end pin, shafts, gears, hook collar and bearings.
- c. Inspect for wear on the tip of the pawl, teeth of the ratchet and pockets of the liftwheel and handwheel.
- d. Loose or missing bolts, nuts, pins or rivets.
- e. Inspect brake components for worn, glazed or contaminated friction discs and scoring of the handwheel hub, ratchet and friction hubs. Replace friction discs if the thickness is less than 1.22mm on 500kg and 1000kg units and 1.35mm on 1500kg to 20000kg units.
- f. Corroded, stretched or broken pawl spring.
- g. Free movement of the pawl on the pawl stud. Also, apply a thin coat of lubricant to the pawl stud before reassembling the unit.
- h. Hooks - dye penetrant, magnetic particle or other suitable crack-detecting inspections should be performed at least once a year, if external conditions indicate there has been unusual usage.

Any deficiencies noted are to be corrected before the chain block is returned to service. Also, the external conditions may show the need for a detailed inspection which, in turn, may require the use of non destructive-type testing.

Any parts that are deemed unserviceable are to be replaced with new parts before the unit is returned to service. It is very important that the unserviceable parts be destroyed to prevent possible future use as a repair item and properly disposed of.

CAUTION

NOTE: Only qualified personnel to perform chain block maintenance.

Hook Inspection

Hooks damaged from chemicals, deformations or cracks that have more than a 10° twist from the plane of the unbent hook or excessive opening or seat wear must be replaced.

Also, hooks that are opened and those that allow the latch to disengage the tip, must be replaced. Any hook that is twisted or has excessive throat opening or seat wear must be replaced.

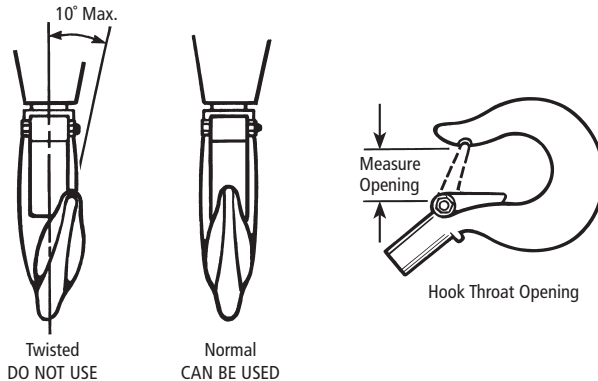

Any hook that is twisted or has excessive throat opening, indicates abuse or over loading of the unit. Other load sustaining components of the chain block should be inspected for damage. The chart above should be used to determine when the hook must be replaced. To measure throat opening, depress the latch against the hook body as shown above.

Chain Block Rated Load Kg	Replace Hook when Opening is greater than: mm
1000	29.4
1500	33.6
2000	37.8

Also check to make sure that the latch is not damaged or bent and that it operates properly with sufficient spring pressure to keep the latch tightly against the tip of the hook and allow the latch to spring back to the tip when released. **If the latch does not operate properly, it should be replaced.**

Load Chain Cleaning and Inspection

First clean the load chain with a non-acid or non-caustic type solvent then slack the chain and make a link by link inspection for nicks, gouges, twisted links and excessive wear or stretching. Worn chain should be gauged throughout its entire length and replaced if beyond serviceable limits.

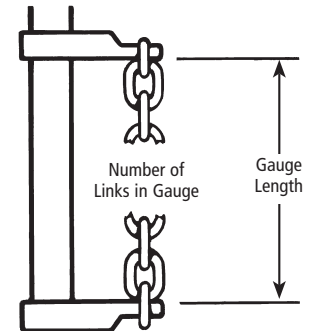

To determine if load chain should be continued in service, check gauge lengths as indicated below. Chain worn beyond length indicated, nicked, gouged or twisted should be replaced before returning chain block to service. Chain should be clean, free of twists and pulled taut before measuring. In cases where the wear is localised and not beyond serviceable limits, it is sometimes possible to reverse the load chain, end for end and allow a new section to take the wear. Proper installation of the load chain is covered in the section on Reeving Load Chain (page 12).

Chain Block Rated Load Kg	Chain Stock Diameter mm	No. of links to Gauge	Max. Length Allowable for Used Chain mm
1000	6	11	206.00
1500	7	11	234.83
2000	8	11	263.65
Hand Chain	5	15	381.20

Note that worn chain can be an indication of worn chain block components. For this reason, the chain block's chain guide roller and lift wheel should be examined for wear and replaced as necessary when replacing worn chain. Also load chains are specially heat treated and hardened and should **never** try to be repaired.

WARNING

Using other than Baoli supplied load chain may cause the chain to jam in the chain block and/or allow the chain to break and the load to drop.

TO AVOID INJURY

Due to the size requirements and physical properties, use only Baoli Alloy Load Chain in the Chain Block.

Important. Do not use replaced chain for other purposes such as lifting or pulling. Load chain may break suddenly without visual deformation. For this reason, cut replace chain into short lengths to prevent use after disposal.

Before returning chain to service or after replacing a load chain, lubricate liberally with chain oil or equal lubricant. Remove excess lubricant from the chain by wiping with a cloth.

Hand Chain

Hand Chain should be cleaned, inspected and gauged in the same manner as load chain.

As received from the factory, the hand chain may contain an unwelded link. This link can be placed in a vice and twisted open to facilitate changing chain length. Please note that opening and closing of the connecting link more than twice is not recommended. Also, connecting links must not be made by cutting the weld side of a standard hand chain link.

Hand chain should be assembled to hand wheel free from twists with weld on vertical link facing inwards towards hand wheel and weld on horizontal link facing towards the hand wheel side plate.

Care must be taken to assure that there is no twist in the hand chain loop.

Lubrication

Lubricate load chain with a light coat of chain oil or equal lubricant. Be sure the lubricant reaches the bearing surfaces between the links. Remove excess oil from the chain.

WARNING

Used motor oil contain unknown carcinogenic materials.

TO AVOID HEALTH PROBLEMS

Never use used motor oils as a chain lubricant. Only use chain oil as a lubricant for the load chain.

The chain block normally requires no additional lubricant except for periodically lubricating the load chain as indicated or when the unit is disassembled for periodic inspections, cleaning or repairs.

The brake is designed to operate dry. Do not use any grease or lubricant on the braking surfaces. When lubricating parts adjacent to the brake, do not use an excessive amount of lubricant which could seep onto the brake surface.

WARNING

Using any grease or lubricant on the braking surfaces will cause brake slippage and loss of load control which may result in injury and /or property damage.

TO AVOID INJURY

Do not use any grease or lubricant on the braking surfaces. The brake is designed to operate dry.

When the chain block is disassembled for periodic inspections, check the pawl for free movement and apply a light coat of WD-40 or similar lubricant to the pawl stud. When the chain block is disassembled for cleaning or repairs, the following locations should be lubricated using approximately 29.5ml per chain block of suitable grease or equivalent:

- gears
- liftwheel rollers
- gear bearing rollers
- chain guide and dead end pin

Note: To assure extra long life and top performance, be sure to lubricate the various parts of the chain block using the lubricant specified above.

Disassembly

Two points of caution to be observed in disassembly are:

1. Loose rollers and bearing balls are used in various locations in the units. Care must be taken so as to not lose or misplace these since they may drop from the unit as the various parts are disassembled. The number of rollers or bearing balls used are:

Chain Block Rated Load Kg	Location	Rollers Required
1000	Intermediate Gear	12 each end
1500	Intermediate Gear	12 each end
2000	Intermediate Gear	11 each end
1000	Liftwheel	30 each end
1500	Liftwheel	30 each end
2000	Liftwheel	35 each end

2. The latch is secured to the hook (upper & lower) by a rivet. To remove the latch, it is necessary to remove the head of the rivet by grinding or drilling. For replacement of the latch, refer to paragraph 4 of the Assembly Instructions.

Assembly

Consideration must be given to the following when assembling the chain block:

1. Assemble the brake components as shown below. The ratchet teeth must face, as shown and engage the pawl. Do not lubricate the brake surfaces. The brake operates dry. Assemble handwheel to pinion shaft and turn handwheel to seat brake components. Assemble the pinion shaft nut to the shaft until the nut bottoms. Then back nut off at least one but not more than two flats. Insert cotter pin and bend ends to secure same.
2. The intermediate gears have timing marks (letter 'O' stamped on one tooth). The gears must be assembled with these marks orientated as shown below.
3. For proper operation, the correct number of rollers must be installed at the rotating points of the liftwheel, intermediate gears. Refer to Disassembly Instructions (page 11) for the number of rollers at these locations. Applying grease or equal lubricant to the rollers or bearing balls will help hold them in position during assembly.
4. When assembling the latch to the hook, the end of the rivet must be peened over. When peening over the rivet, only apply enough force to form the head and retain the rivet. Excessive force will deform the latch and make the latch inoperable.

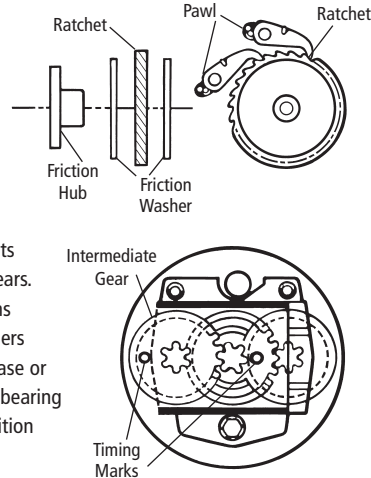

Reeving Load Chain

A. 500, 1000, 1500 and 2000Kg Chain Blocks.

Attach approximately 500mm of soft wire to the loose end of the chain. Pass the wire over the top of the liftwheel and down between the liftwheel and the chain guide. Position the chain so that the first, as well as the third, link stands on edge with the weld away from the liftwheel and the second link lays flat on the liftwheel. After the chain has been started, pull hand chain in the hoisting direction until about 0.6m of chain has passed the liftwheel. The wire should now be removed from the chain. Remove the cotter pin from the loose end pin and slide the loose end pin to the side into the bear housing leaving approximately 12.7mm of the pin protruding from the geared side plate. Loop the chain, making sure there are no twists, up to the loose end pin and slide the pin through the last link of the chain. Slide the loose end pin into hole in the handwheel side plate until the cotter pin hole is visible. Secure the loose end pin by reinstalling the cotter pins and spreading the legs of the cotter pins. 3, 5, 10 and 20 tonne chain blocks have multiple falls and are required to be reeved by Baoli Brands or our authorised dealers only.

⚠ WARNING

Failure to properly install the load chain between guide and liftwheel may cause the chain to lift out of the liftwheel pockets and allow the load to drop.

TO AVOID INJURY

Feed load chain between liftwheel and chain guide as shown above before attaching it to the loose end pin.

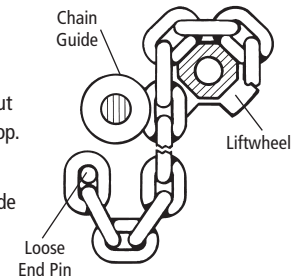

Exterior Finish

The exterior surfaces of the chain blocks have a durable, scratch resistant finish. Normally, the exterior surfaces can be cleaned by wiping with a cloth.

Recommended Spare Parts

To insure continued operation it is recommended that two friction washers for each chain block in service, Key no 'P', be kept on hand at all times to replace friction washers that are worn, contaminated or glazed. Contact your nearest Baoli Brands office for details.

Preventative Maintenance

In addition to the periodic inspection procedure, a preventative maintenance program should be established to prolong the useful life of the chain block and maintain its dependability and continued safe use. The program should include the periodic inspections with particular attention being paid to the lubrication of various components using the recommended lubricants.

Testing

Before using, all altered, repaired or used chain blocks that have not been operated for the previous 12 months, should be tested by the user for proper operation. First test the unit without a load and then with a light load of 20 kg to be sure that the chain block operates properly and that the brake holds the load when the hand chain is released. Next test with a load of 100% rated capacity. In addition, chain blocks in which load sustaining parts have been replaced should be tested with 100% of rated capacity by or under the direction of an appointed person and a written report prepared for record purposes.

Ordering Information

The following information must accompany all correspondence or repair parts orders:

Chain Block capacity

Serial Number - stamped on the capacity label

For parts orders also specify:

Quantity desired

Key number of part

Part name

Part number

When ordering replacement parts, consideration should be given to the need to replace other items, (springs, fasteners etc) and items that may be damaged or lost during disassembly or just unfit for future use because of deterioration from age or service.

Parts should be ordered from Baoli . Using

'commercial' or other manufacturer's parts to repair the Baoli Chain Block may cause load loss.

WARNING

TO AVOID INJURY

Use only Baoli supplied replacement parts. Parts may look alike, but Baoli Brands parts are made of specific materials or processed to achieve specific properties.

Specifications and Dimensions

Item No.	01032	01033	01034	
Capacity(kg)	1000	1500	2000	
Standard lift(m)	3	3	3	
No. of load chain falls	1	1	1	
Load Chain Dia. mm	6*18	7*21	8*24	
Effort required to lift Max.load(N)	284	380	343	
Dimension (mm)	A(mm)	161	182	202
	B(mm)	154	176	177
	C(mm)	27	33	35
	D(mm)	40	45	50
	Hmin(mm)	383	442	485

Other lifts of chain are available on request.

NOTE: Product code for 6 metre lifts = replace last digit 3 with 6

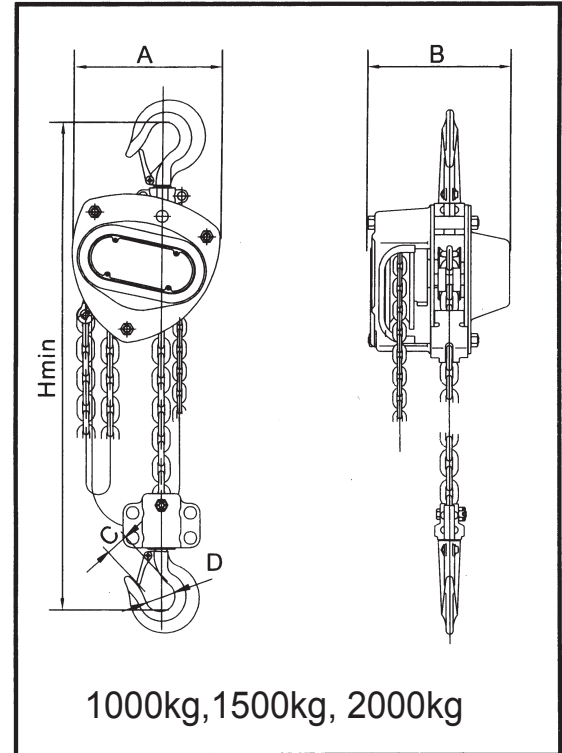

Spare Parts Diagram

NO.	DESCRIPTION
1	Hand wheel cover assembly
2	Hand wheel
3	Brake cover
4	Friction plate
5	Ratchet disc
6	Brake seat
7	Lock plate
8	Top pin
9	Side plate assembly B
10	Chain sprocket
11	Side plate assembly A
12	Splined gear
13	Driven shaft assembly
14	Driving shaft
15	Gear case assembly
16	Name plate
17	Suspension plate
18	Stripper

19	Guide roller
20	Load chain
21	Pawl spring
22	Pawl
23	Hand chain
30	Top hook assembly
31	Double spring
32	Safety latch
33	Chain pin
34	Bottom hook assembly

Exploded view 1000kg to 2000kg

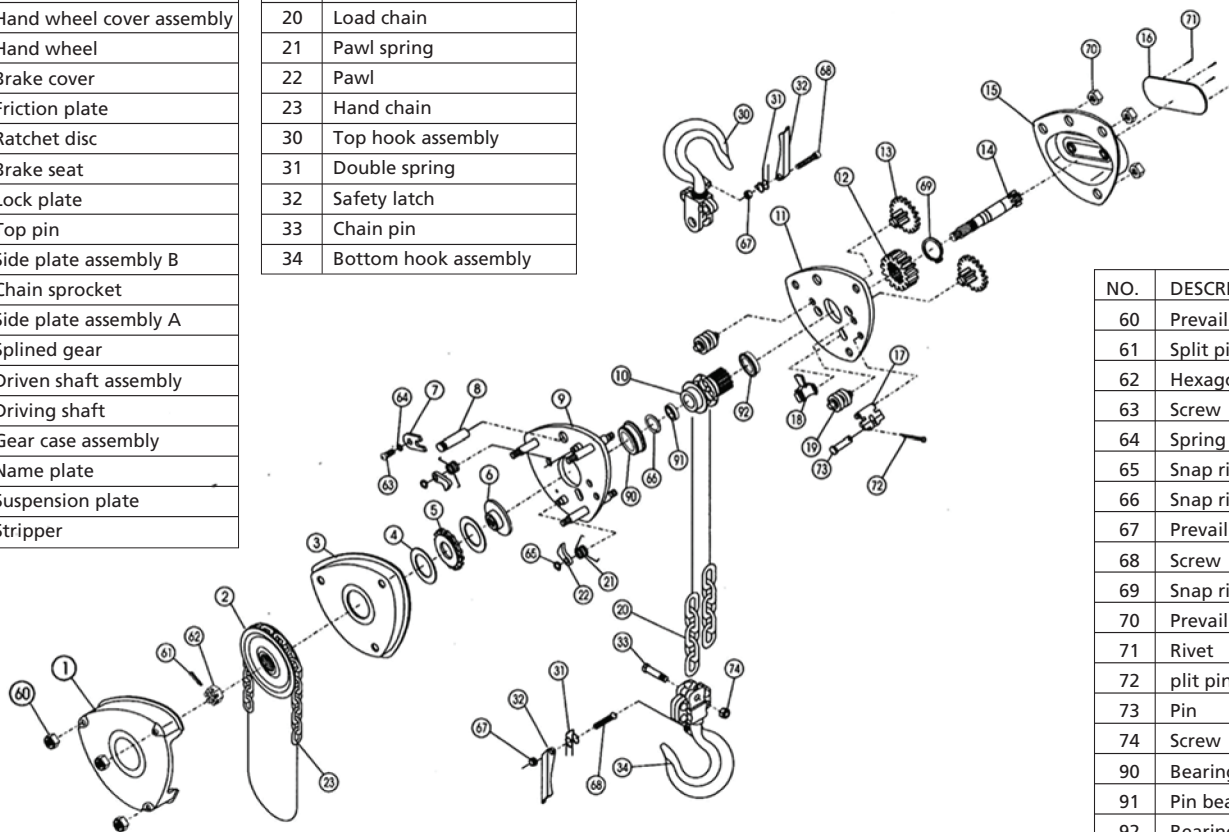

NO.	DESCRIPTION
60	Prevailing torque type nut
61	Split pin
62	Hexagonal castle nut
63	Screw
64	Spring washer
65	Snap ring
66	Snap ring
67	Prevailing torque type nut
68	Screw
69	Snap ring
70	Prevailing torque type nut
71	Rivet
72	plit pin
73	Pin
74	Screw
90	Bearing A
91	Pin bearing
92	Bearing B

IMPORTANT INFORMATION

1 Year Limited Warranty

Baoli offers a one year limited warranty on this product

Baoli warrants to the original retail consumer and purchaser that this product will be free from defects in materials and workmanship for one year from the date the product was purchased ('the warranty period').

Baoli will rectify any defect in materials or workmanship appearing within the warranty period by repairing or replacing the product. Baoli will offer a refund of the purchase price if the product cannot be readily and quickly repaired or replaced. Baoli reserves the right to determine whether the product contains any defects in materials or workmanship covered by this warranty.

The benefits offered by this warranty are in addition to your rights and remedies that may apply in law. Our goods come with guarantees that cannot be excluded under the Australian Consumer Law. You are entitled to a replacement or refund for a major failure and for compensation for any other reasonable foreseeable loss or damage. You are also entitled to have the goods repaired or replaced if the goods fail to be of acceptable quality and the failure does not amount to a major failure.

How to make a warranty claim

To make a claim under this warranty, the product or part must be returned for examination to an authorised service centre nominated by Baoli together with proof of purchase such as the dated sales receipt and an explanation of the problem to be rectified.

Any costs incurred in making a claim under this warranty or returning the product to an authorised service centre is to be borne by the person making the claim unless otherwise agreed by Baoli. If Baoli determines the product contains a defect in materials or workmanship that is covered by this warranty then Baoli will bear the cost of returning the repaired product or replacement product to the person making the claim. If We determines the product does not contain a defect in materials or workmanship covered by this warranty then the cost of returning the product will be at the expense of the person making the claim.

Exclusions

This warranty does not apply to any defect caused by, or associated with misuse, abuse, lack of maintenance, negligence or accidents, repairs or alterations not authorised by Baoli International.